

10" Woodworking Bandsaw

Model: 10-300

RIKON

POWER TOOLS



Owner's Manual

Record the serial number and date of purchase
in your manual for future reference.

Serial number: _____

Date of purchase: _____

For more information:
www.rikontools.com or info@rikontools.com
For Parts or Questions:
techsupport@rikontools.com or 877-884-5167

TABLE OF CONTENTS

Safety Instructions.....	3-4
Carton Contents.....	5
Hardware Package Contents.....	5
Assembly.....	6
Installing the Table.....	6
Centering the Table.....	6
Setting the Table Square with the Blade.....	6
Mounting the Bandsaw.....	7
Dust Collection.....	7
Installing/Changing the Blade.....	7-8
Tracking the Bandsaw Blade.....	8
Adjusting the Blade Guides.....	8
Setting the Cutting Height.....	8
Tilting the Bandsaw Table.....	8
Operation.....	9
Maintenance.....	9
Troubleshooting.....	10
Electrical Schematic.....	11
Electrical Requirements.....	12
Parts List.....	13
Parts Explosion.....	14
Notes.....	15
Warranty.....	16

SPECIFICATIONS

Throat width	9-5/8" (244 mm)
Max. cutting depth	3-3/8" (86 mm)
Blade length	67-1/2" (1714 mm)
Blade width	1/8" – 1/2"(3-13 mm)
Table size	11-13/16" x 11-13/16"
Table tilt	Left-1° Right-45°
Blade speed	2,780 ft/min
Motor	1/3 HP
Amps	4.5
Volts	110V
Net weight	55 lbs

SAFETY INSTRUCTIONS

General Safety Warnings

KNOW YOUR POWER TOOL. Read the owner's manual carefully. Learn the tool's applications, work capabilities, and its

⚠ DANGER



Always Ground All Tools.

If your tool is equipped with a three-pronged plug, you must plug it into a three-hole electric receptacle. If you use an adapter to accommodate a two-pronged receptacle, you must attach the adapter plug to a known ground. Never remove the third prong of the plug.

Always Avoid Dangerous Environments.

Never use power tools in damp or wet locations. Keep your work area well lighted and clear of clutter.

⚠ DANGER



Always Remove the Adjusting Keys and Wrenches from Tools after Use.

Form the habit of checking to see that keys and adjusting wrenches are removed from the tool before turning it on.

Always Keep Your Work Area Clean. Cluttered areas and benches invite accidents.

⚠ DANGER



Always Keep Visitors Away from Running Machines.

All visitors should be kept a safe distance from the work area.

Always make the Workshop Childproof.

Childproof with padlocks, master switches, or by removing starter keys.

⚠ DANGER



Never operate a tool while under the influence of drugs, medication, or alcohol.

⚠ DANGER



Always Wear Proper Apparel.





Never wear loose clothing or jewelry that might get caught in moving parts. Rubber-soled footwear is recommended for the best footing.

⚠ DANGER



Always Use Safety Glasses and Wear Hearing Protection.

Also use a face or dust mask if the cutting operation is dusty.

	<p>⚠ DANGER</p> <p>Never Overreach. Keep your proper footing and balance at all times.</p>
	<p>⚠ DANGER</p> <p>Never Stand on Tools. Serious injury could occur if the tool is tipped or if the cutting tool is accidentally contacted.</p>
	<p>⚠ DANGER</p> <p>Always Disconnect Tools. Disconnect tools before servicing and when changing accessories such as blades, bits, and cutters.</p> <p>Always Avoid Accidental Starting. Make sure switch is in "OFF" position before plugging in cord.</p> <p>Never Leave Tools Running Unattended.</p>
	<p>⚠ DANGER</p> <p>Always Check for Damaged Parts. Before initial or continual use of the tool, a guard or other part that is damaged should be checked to assure that it will operate properly and perform its intended function. Check for alignment of moving parts, binding of moving parts, breakage of parts, mounting, and any other conditions that may affect its operation. A guard or other damaged parts should immediately be properly repaired or replaced.</p>

Special Safety Rules For Bandsaws

1. Always stop the Bandsaw before removing scrap pieces from table.
2. Always keep hands and fingers away from the blade.
3. Never attempt to saw stock that does not have a flat surface, unless a suitable support is used.
4. Always hold material firmly and feed it into the blade at a moderate speed.
5. Always turn off the machine if the material is to be backed out of an uncompleted cut.
6. Adjust the upper guide about 1/8" to 1/4" above the material being cut.
7. Check for proper blade size and type for thickness and type of material being cut.
8. Make sure that the blade tension and blade tracking are properly adjusted.
9. Make "relief" cuts before cutting long curves.
10. Release blade tension when the saw will not be used for a long period of time.

CARTON CONTENTS

The model 10-300 10" Bandsaw is shipped complete in one box.

Unpacking and Checking Contents

- a. Separate all parts from carton and check each item with "Table of Carton Contents" to make sure all items are accounted for, before discarding any packing material.
- b. Remove the protective oil that is applied to the table. Use any ordinary house hold type grease and spot remover.
- c. Apply a coat of paste wax to the table to prevent rust. Wipe all parts thoroughly with a clean dry cloth.

CARTON CONTENTS

Item	Description	Q'ty.
A	Main Machine.....	1
B	Table.....	1
C	Owner's Manual.....	1
D	Upper Table Trunnion Assembly.....	1
E	Bag of Loose Parts.....	1

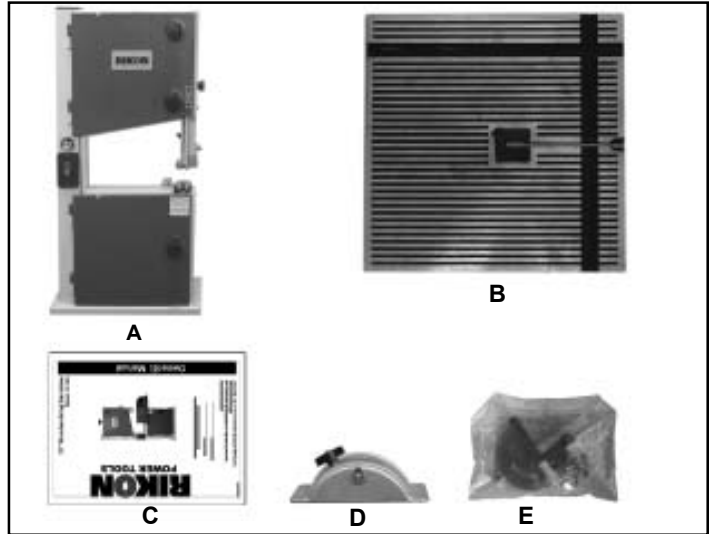





HARDWARE PACKAGE CONTENTS





Unpacking and Checking Contents

Separate all parts from loose bags and check each item with "Table of hardware package contents" to make sure all items are accounted for, before discarding any packing material.

LIST OF LOOSE PARTS IN BAG

Item	Description	Qty
	Blade Tension Knob.....	1
	Miter Gauge.....	1
	Hex. Socket Head Cap Screw M6x30.....	1
	Washer 6.....	1
	Wing Nut M6.....	1

LIST OF LOOSE PARTS IN BAG

Item	Description	Qty
	Hex. Bolt M6x12.....	4
	Lock Washer 6.....	4
	M3 Hex "L" Wrench.....	1
	M5 Hex "L" Wrench.....	1

ASSEMBLY

Initial Assembly

The machine is supplied partly assembled. Prior to use, the following items have to be installed: bandsaw table, star knob (blade tensioning) and rip fence.

WARNING: To avoid injury, do not attempt to run or use this machine until all parts are assembled and working properly.

Installing the Table

- Place table on to the upper table trunnion, taking care when passing the saw blade through the slot in the table (See Fig. 1). Mount the working table to the upper trunnion with four hex bolts and four lock washers. (A--Fig. 2)
- Use the hex socket screw, bushing, washer and wing nut for correcting the working table flatness. (B--Fig. 2)
- Place star knob on to tension rod (See Fig. 3).

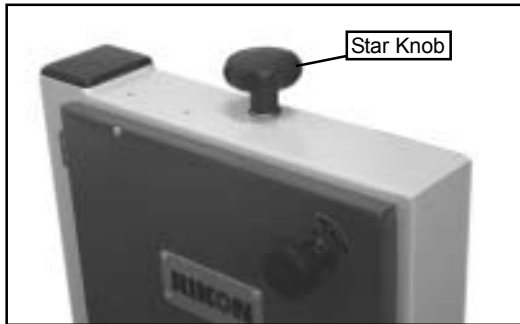

Fig.3

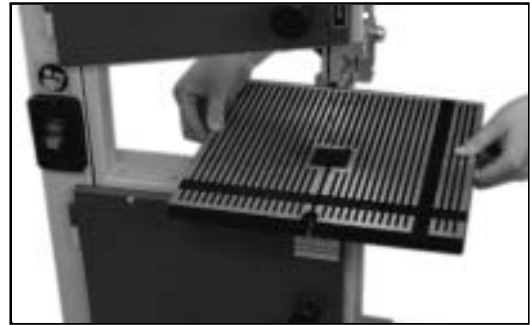

Fig.1



Fig.2

Centering the Table

- Loosen the four bolts mounting the table to the upper trunnion. (A-Fig. 4)
- Move table sideways as required, until saw blade runs through the center of table insert.
- If the adjustment of "b" is not enough to center the table, loosen the bolts holding the lower table trunnion and move the table sideways to place the table in the center. (B-Fig. 4)
- Re-tighten trunnion bolts, recheck blade position.

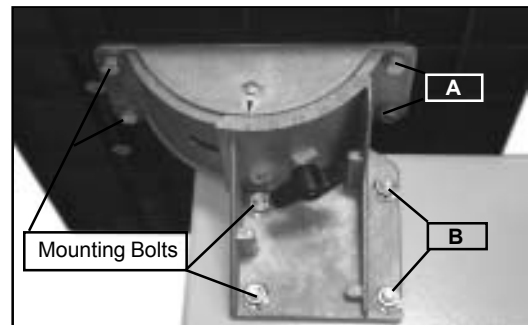

Fig.4

Setting the Table Square with the Saw Blade

Loosen the wing nut and place a suitably sized square against the saw blade. If table requires adjustment, proceed as follows:

- Using a 10mm wrench, release lock nut on the table stop.
- Place wrench on bolt and adjust until table is set square to blade.
- Tighten M10 lock nut and recheck blade and table for squareness.
- Lock table into position and check that pointer reads zero degrees on side of trunnion. Loosen then screw securing pointer and reset if necessary to give zero degree reading (See Fig. 5).

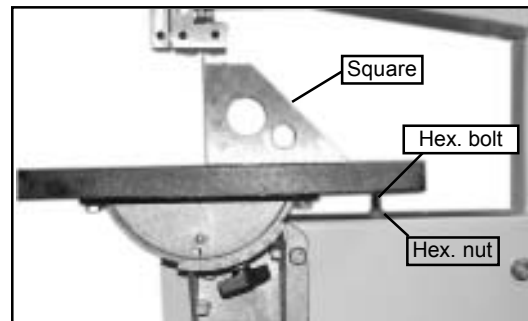

Fig.5

Mounting the Bandsaw

For maximum stability during use, it is strongly recommended that the bandsaw be mounted on a sturdy bench or worktable. It should be bolted down utilizing the 1/4" holes in the bandsaw base plate. (See Fig. 6)

Dust Collection

The bandsaw has a 2-1/2" dust extraction port (See Fig. 7) included.

It is recommended that when in use, the bandsaw is connected to a suitable dust collector.

Installing/Changing and Setting the Saw Blade

This bandsaw is factory-equipped with a general-purpose wood cutting blade, the blade is set prior to delivery. To change the blade, the following procedure must be followed:

WARNING: To avoid injury from unexpected starting, whenever changing blade or carrying out adjustments, switch bandsaw off and remove power cord from the main outlet. To avoid injury to hands when handling saw blade, wear gloves whenever necessary.

- a. Remove the leveling wing nut and screw from table.
- b. Open top and bottom bandsaw wheel doors by releasing the door locks.
- c. Loosen the blade tension by turning the star knob on the top of the upper wheel housing counter-clockwise (viewed from above) (See Fig. 8).
- d. Remove the saw blade by feeding it through the slot in the table, upper blade guides and guard and the slot in the spine of the bandsaw.
- e. When fitting the new blade ensure the blade teeth are pointing downwards and towards you at the position where the blade passes through the table.
- f. Re-tension the new blade and check the blade tracking by turning the upper wheel by hand. The blade should run in the center of the bandsaw wheel (See Fig. 9).
- g. If required, adjust the tracking by using the tracking knob and locking wing nut (See Fig. 10 page 8) to the rear of the upper bandsaw wheel housing. When tracking is correct, tighten the locking wing nut.



Fig.6



Fig.7

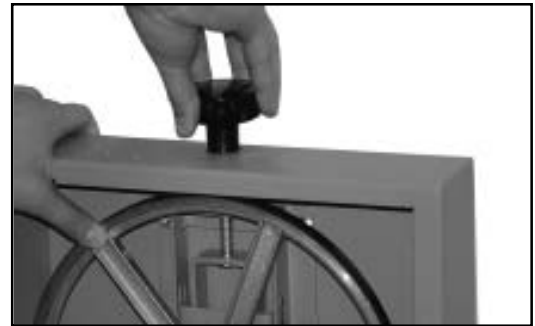

Fig.8



Fig.9

Installing/Changing and Setting the Saw Blade Cont.

- h. Replace leveling wing nut and screw to table.
- i. Close and lock both bandsaw wheel doors before reconnecting the power supply.

Tracking the Bandsaw Blade

Set the tracking of the blade before setting the blade guides. Once the blade is installed and tensioned, track the blade by adjusting the tracking knob by hand (See Fig. 10). The blade should run in the center of the bandsaw wheel as shown in (See fig. 9). When the correct adjustment is achieved lock the tracking knob with the wing nut. (See Fig. 10)

Adjusting the Blade Guides

The saw blade guides of this bandsaw ensure exact blade position for clean cuts. When using narrow blades, ensure that the upper and lower blade guides positively support the blade from both sides and the rear (See Fig. 11).

Set the bearings of the upper and lower blade guides to within approximately $1/64$ " of the blade. Adjust the rear upper and lower thrust bearings to the back of the blade. Position the thrust bearings so they do not spin while blade is moving, only when pressure is applied to the blade during cutting operation (See Fig. 12).

NOTE: Do not set bearings too close, as resulting friction generates heat, which may have an adverse effect on the bearings and the saw blade as well.

Setting the Cutting Height

- a. The upper blade guide should always be set approximately $1/4$ " above the workpiece.
- b. To adjust, loosen the wing nut at the side of the upper wheel housing (See Fig. 13).
- c. Set the blade guide to the required height by raising or lowering the blade guard by hand.
- d. Tighten wing nut after proper height is set (See Fig. 13).

Tilting the Bandsaw Table

For bevel cuts, the bandsaw table tilts 0 through 45 degrees.

- a. To tilt, loosen the wing nut on the table trunnion, set table to the required angle and tighten the wing nut again. (See Fig. 14)
- b. It is recommended to verify the correct angle setting using an angle guide, or by making trial cuts in scrap wood. Adjust the pointer accordingly by using a phillips head screwdriver.

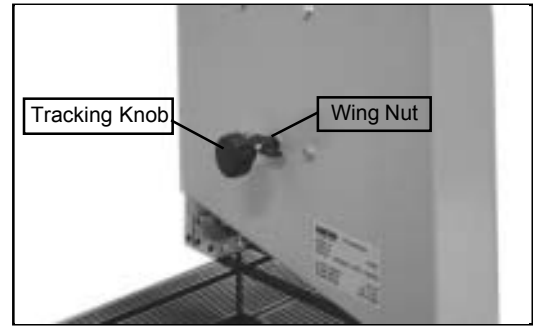

Fig.10



Fig.11

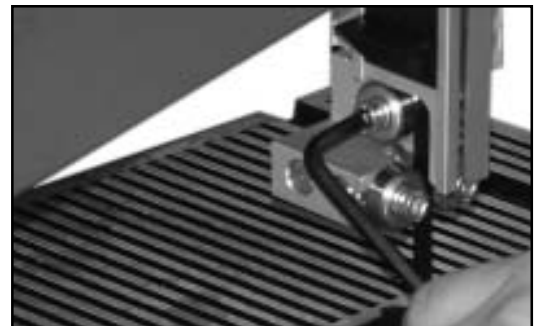

Fig.12

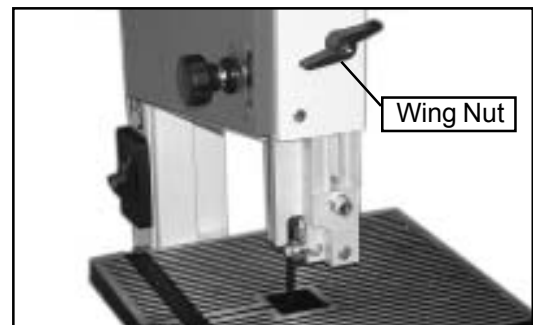

Fig.13

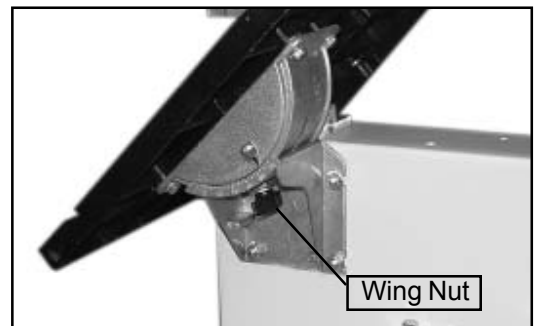

Fig.14

OPERATION

1. The blade cuts on a continuous down-stroke.
2. Check all the necessary settings and adjustments, and ensure that all the recommended safety procedures are in place.
3. Start the bandsaw by placing the switch towards the 'on' position.
4. Wait for the saw to come to full speed before starting to cut. Never start the saw with the workpiece in contact with the saw blade.
5. Slowly feed the workpiece towards the blade, putting only light pressure on it.
6. With both hands, firmly hold the workpiece down on the table, and feed it towards the blade slowly (See Fig. 15).



Fig.15

WARNING: To avoid injury when hands are unavoidably near to the blade, they should be placed on either side of the blade, not in line with it. Use a push stick whenever possible when working in close proximity to the blade.

7. For best results the blade must be sharp.
8. Select the right blade for the job, depending on the thickness of the wood to be cut. The thinner and harder the wood, the finer the teeth of the blade. Use a fine tooth blade for cutting sharp curves.
9. Use the fence provided to feed the workpiece along the blade slowly and in a straight line.
10. The machine is especially suited for cutting curves, but will also make straight cuts.
11. When cutting, follow the design marked out by pushing and turning the workpiece evenly.
12. Do not attempt to turn the workpiece without pushing it, as this may cause the workpiece to get stuck, or the blade to bend.
13. Use the miter gauge for angle cutting (See Fig. 16).

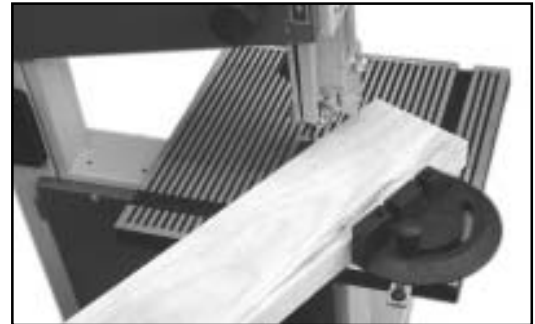

Fig.16

MAINTENANCE

WARNING: To avoid injury due to unexpected starting, before cleaning or carrying out maintenance work, switch off and disconnect the bandsaw from the power source.

Never use water or other liquids to clean the bandsaw. Use a dry brush.

Regular maintenance of the bandsaw will prevent unnecessary problems.

1. Keep the table clean to ensure accurate cutting.
2. Keep the outside of the machine clean to ensure accurate operation of all moving parts and prevent excessive wear.
3. Keep the ventilation slots of the motor clean to prevent it from overheating.
4. Keep the inside (near the saw blade, etc.) clean to prevent accumulation of dust. Use dust collection if possible.
5. To prolong the life of the blade, when the bandsaw is not in use for extended periods, release the blade tension. Before reusing the bandsaw ensure that the blade is re-tensioned and tracking is checked.

Changing Drive Belt

1. Release saw blade tension by turning star knob on the top of upper bandsaw cabinet counter-clockwise.
2. Using a 6mm hexagonal wrench to release socket head cap screw on motor mounting flange. (See Fig. 17)



Fig.17

3. Using c-clip pliers (not provided) remove c-clip from center of lower bandsaw wheel.
4. Carefully slide bandsaw wheel forward and at the same time release saw blade from wheel. (See Fig. 18)



Fig.18

5. Remove old drive belt and fit new belt. Make sure ribs in drive belt are seated correctly before reassembly and tensioning belt.
6. Follow procedure for Changing and Setting Blade / Tracking the Bandsaw Blade Guide, before restoring power to the saw and setting up for use.

TROUBLE SHOOTING

Problem	Diagnosis	Remedy
The machine does not work when switched on.	<ol style="list-style-type: none"> 1. No power supply. 2. Defective switch. 	<ol style="list-style-type: none"> 1. Check the cable for breakage. 2. Check the fuse or breaker. 3. Contact you local dealer for repair parts.
The blade does not move with the motor running.	<ol style="list-style-type: none"> 1. The blade tension knob has not been tightened. 2. The blade has come off one of the wheels. 3. The saw blade has broken. 4. The drive belt has snapped. 	<ol style="list-style-type: none"> 1. Switch off the motor, tighten the blade tension knob. 2. Open the hinged door and check. 3. Replace the blade. 4. Replace the belt.
The blade does not cut in a straight line.	<ol style="list-style-type: none"> 1. Fence for cutting not used. 2. Feed rate too fast. 3. The blade teeth are dull or damaged. 4. Blade guides not suitably adjusted. 	<ol style="list-style-type: none"> 1. Use a fence. 2. Put light pressure on the workpiece. Make sure the blade does not bend. 3. Try a new blade. 4. Adjust the blade guides(see assembly)
The blade does not cut, or cuts very slowly.	<ol style="list-style-type: none"> 1. The teeth are dull, caused by cutting hard material or long use. 2. The blade was fitted the wrong way on the bandsaw. 	<ol style="list-style-type: none"> 1. Replace the blade, use a 6 T.P.I. blade for wood and soft material. Use a 14 T.P.I. blade for harder materials. A 14 T.P.I. blade always cuts slower due to the finer teeth and the slower cutting performance. 2. Install the blade correctly.
Sawdust builds up inside the machine.	Excessive dust build-up on the machine interior components.	Clean the machine regularly. Attach to a suitable dust collection system.
Sawdust inside the motor housing.	Excessive dust build-up on the machine exterior components.	Clean the ventilating slots of the motor with a vacuum cleaner. From time to time remove the sawdust to prevent it from being drawn into the housing.
The machine does not cut at 45 or 90 degrees.	<ol style="list-style-type: none"> 1. The table is not at right angles to the blade. 2. The blade is dull or too much pressure was put on the workpiece. 	<ol style="list-style-type: none"> 1. Adjust the table. 2. Replace the blade or put less pressure on the workpiece.
The blade can not be properly positioned on the bandsaw wheel.	<ol style="list-style-type: none"> 1. The wheels are not in alignment or defective bearing. 2. The wheel alignment knob hasn't been properly adjusted. 3. Inferior blade. 	<ol style="list-style-type: none"> 1. Contact you local dealer for repair parts. 2. Adjust the knob (See instructions). 3. Replace the blade.

ELECTRICAL SCHEMATIC

WARNING: This machine must be grounded.

To avoid electrocution or fire, any repairs to electrical system should be done only by a qualified electrician, using genuine replacement parts.

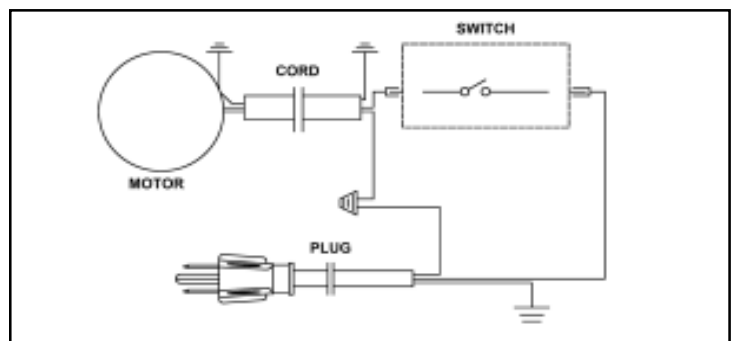

Electrical Requirements

In the event of a malfunction or breakdown, grounding provides a path of least resistance for electric current to reduce the risk of electric shock. This tool is equipped with an electric cord having an equipment-grounding conductor and a grounding plug. The plug must be plugged into a matching outlet that is properly installed and grounded in accordance with all local codes and ordinances.

Do not modify the plug provided. If it will not fit the outlet, have the proper outlet installed by a qualified electrician.

Improper connection of the equipment-grounding conductor can result in a risk of electric shock. The conductor, with insulation having an outer surface that is green with or without yellow stripes, is the equipment-grounding conductor. If repair or replacement of the electric cord or plug is necessary, do not connect the equipment-grounding conductor to a live terminal.

Check with a qualified electrician or service personnel if the grounding instructions are not completely understood, or if in doubt as to whether the tool is properly grounded.

Use only three wire extension cords that have three-prong grounding plugs and three-pole receptacles that accept the tool's plug.*

Repair or replace a damaged or worn cord immediately.

This tool is intended for use on a circuit that has an outlet that looks the one illustrated in Figure A below. The tool has a grounding plug that looks like the grounding plug as illustrated in Figure A below. A temporary adapter, which looks like the adapter as illustrated in Figure B below, may be used to connect this plug to a two-pole receptacle, as shown in Figure B if a properly grounded outlet is not available.** The temporary adapter should only be used until a properly grounded outlet can be installed by a qualified electrician. The green colored rigid ear or tab, extending from the adapter, must be connected to a permanent ground such as a properly grounded outlet box.

* Canadian electrical codes require extension cords to be certified SJT type or better.

** Use of an adapter in Canada is not acceptable.

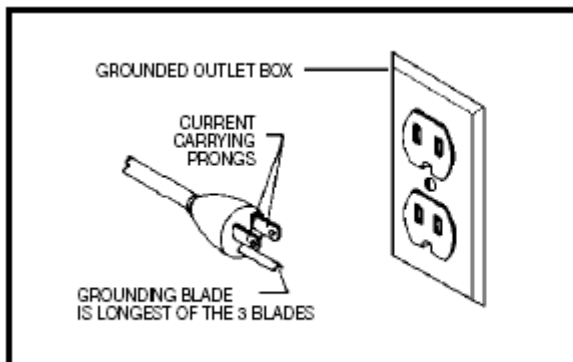

Fig. A

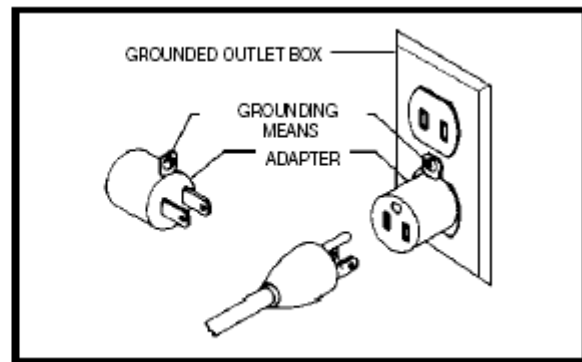
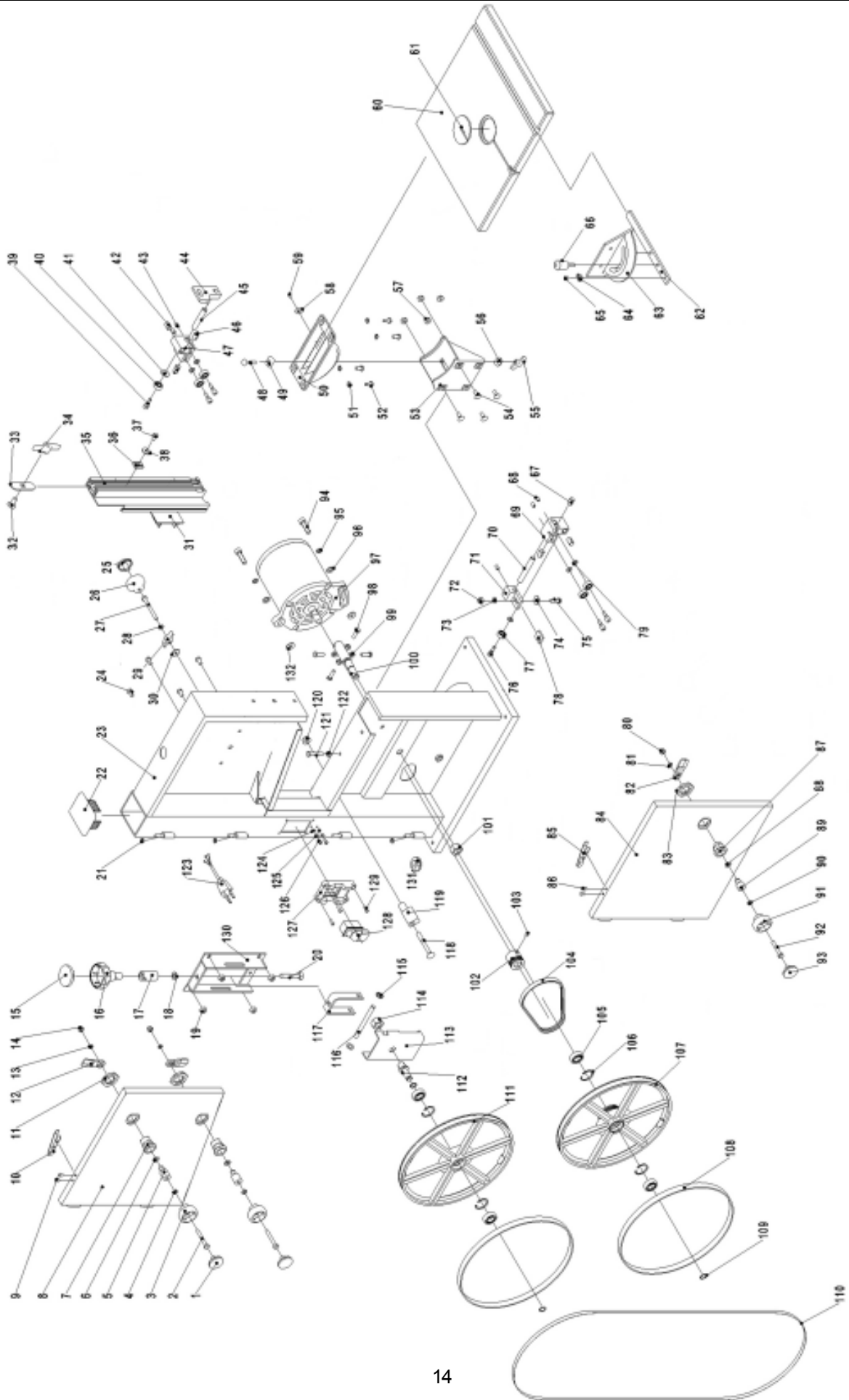

Fig. B

Parts List

Key No.	Part#	Description	Key No.	Part#	Description
1	JL20061101-081S	Knurled Knob Cap	67	1-JL22042004	Bearing Mount Cylinder
2	1-M6X40GB5781Z	Hex. Bolt M6x45	68	1-M6X10GB80B	Hex. Socket Set Screw M6x10
3	1-JL20061102-081S	Knurled Knob Body	69	1-JL22043001	Lower Guide Body
4	1-M6GB6172Z	Hex. Nut M6	70	1-JL22043002	Lower Guide Shaft
5	1-JL20010010D	Slotted Insert	71	1-JL22043003	Lower Guide Mount
6	1-JL20010014	Special Spring Washer 10	72	1-M6GB889Z	Lock Nut M6
7	1-JL20010011A001S	Lock Housing	73	1-WSH6GB97D1Z	Washer 6
8	1-JL22012000B049W	Upper Door	74	1-WSH6GB96Z	Washer 6
9	1-RVT4X8GB12618A	Rivet 4x8	75	1-M6X20GB5783Z	Hex. Bolt M6x20
10	1-JL22010008	Leaf Spring	76	1-JL22042005	Guide Adjust Screw
11	1-JL20010012	Special Nut M22	77	1-BRG80026GB278	Ball Bearing 6mm
12	1-JL20010009	Tongue Lock	78	1-JL22040004	Guide Key
13	1-WSH6GB93Z	Spring Washer 6	79	1-WSH6GB97D1Z	Washer 6
14	1-M6GB889ZF	Lock Nut M6	80	1-M6GB889ZF	Lock Nut M6
15	1-JL22024001-001S	Blade Tension Knob Cap	81	1-WSH6GB93Z	Spring Washer 6
16	1-JL22024002-001S	Blade Tension Knob Body	82	1-JL20010009	Tongue Lock
17	1-JL22021003	Blade Tensioner	83	1-JL20010012	Special Nut M22
18	1-WSH8GB97D1Z	Washer 8	84	1-JL22013000-049W	Lower Door
19	1-M6GB6177Z	Flange Nut M6	85	1-JL22010008	Leaf Spring
20	1-M8X50GB14Z	Carriage Bolt M8x50	86	1-RVT4X8GB12618A	Rivet 4X8
21	1-JL20010001	Bushing Ring	87	1-JL20010011-001S	Lock Housing
22	1-JL22010001A-001S	Top Plug	88	1-JL20010014	Special Spring Washer 10
23	1-JL22011000-050W	Frame	89	1-JL20010010D	Slotted Insert
24	1-M6X12GB5781B	Hex. Bolt M6x12	90	1-M6GB6172Z	Hex. Nut M6
25	1-JL20061101-001S	Blade Tracking Knob Cap	91	1-JL20061102-081S	Knurled Knob Body
26	1-JL20061102-081S	Blade Tracking Knob Body	92	1-M6X40GB5781Z	Hex. Bolt M6x40
27	1-M6X60GB5781Z	Hex. Bolt M6x60	93	1-JL20061101-081S	Knurled Knob Cap
28	1-M6GB6172Z	Hex. Nut M6	94	1-M8X30GB70B	Hex. Socket Head Cap Screw M8x30
29	1-JL22020002-001S	Wing Nut M6	95	1-WSH8GB93Z	Spring Washer 8
30	1-WSH6GB96Z	Washer 6	96	1-WSH8GB97D1Z	Washer 8
31	1-JL22041009	Slider	97	1-G7412634A	Motor
32	1-M8X20GB14Z	Carriage Bolt M8x20	98	1-M6X20GB5783Z	Hex. Bolt M6x20
33	1-JL20041004	Bolt Guide	99	1-M6GB6170Z	Hex. Nut M6
34	1-JL20010016-001S	Wing Nut M8	100	1-JL22020004	Lower Bearing Bolt
35	1-JL22041001E	Blade Guide	101	1-M14GB6171Z	Hex. Nut M14
36	1-JL20010005A	Sliding guide	102	1-JL22071001	Motor Pulley
37	1-M6X12GB5781B	Hex. Bolt M6x12	103	1-M6X10GB80B	Hex. Socket Set Screw M6x10
38	1-WSH6GB862D2Z	Lock Washer 6	104	1-JL22020003	Poly-V-Belt
39	1-JL22042005	Guide Adjust Screw	105	1-BRG80101GB278	Ball Bearing 12mm
40	1-BRG80026GB278	Ball Bearing 6mm	106	1-CLP28GB893D1B	Retaining Ring 28
41	1-WSH6GB97D1Z	Washer 6	107	1-JL22023001	Lower Wheel
42	1-JL22042004	Bearing Mount Cylinder	108	1-JL22022002	Tire
43	1-M6X10GB80B	Hex. Socket Set Screw M6x10	109	1-CLP12GB894D1B	Retaining Ring 12
44	1-JL22041003	Upper Guide Mount	110	1-JL22020001	Blade
45	1-JL22042002	Upper Guide Shaft	111	1-JL22022001	Upper Wheel
46	1-JL22042003	Bearing Mount Cylinder w/Cap	112	1-JL22021006	Upper Bearing Bolt
47	1-JL22042001	Upper Guide Body	113	1-JL23021001-050W	Wheel Carrier Bracket
48	1-M6X30GB14Z	Carriage Bolt M6x30	114	1-M14GB6171Z	Hex. Nut M14
49	1-JL22030002-001S	Glide Piece	115	1-JL22021004	Star Lock
50	1-JL22032001	Upper Table Trunion	116	1-JL22021002	Mount Shaft
51	1-WSH6GB862D2Z	Lock Washer 6	117	1-JL22021001-050W	Blade Tensioner
52	1-M6X12GB5781Z	Hex. Bolt M6x12	118	1-M8X70GB14Z	Carriage Bolt M8x70
53	1-JL22030001	Lower Table Trunion	119	1-JL20010004	Brush Strip
54	1-M6X16GB14Z	Carriage Bolt M6x16	120	1-M8GB6177Z	Flange Nut M8
55	1-JL22020002-001S	Wing Nut M6	121	1-M6X35GB12Z	Hex. Bolt M6x35
56	1-WSH6GB96Z	Washer 6	122	1-M6GB6170Z	Hex. Nut M6
57	1-M6GB6177Z	Flange Nut M6	123	2-U23182300-472	Cable w/Plug
58	1-1506003	Indicator	124	1-WSH4GB862D2Z	Lock Washer 4
59	1-ST3D5X9D5GB845Z	Tapping Screw ST3.5x9.5	125	1-WSH4GB97D1Z	Washer 4
60	1-JL22031001-001G	Table	126	1-M4X8GB818Z	Pan Head Screw M4x8
61	1-JL22031002-001S	Table Insert	127	1-JL20070002	Switch Cover Plate
62	1-JL60040002	Aluminium Bar	128	1-J-9301B	Lock Switch
63	1-JL60040001-001S	Miter Gauge Base	129	1-M4X10GB823Z	Pan Head Screw M4x10
64	1-JL60040004	Indicator	130	1-JL22021100-050W	Tension Bracket
64	1-M5X6GB818B	Pan Head Screw M5x6	131	1-JL20072003	Rubber Tube
66	1-JL60040003-001S	Knob	132	1-WSH8GB96Z	Washer 8

Parts Explosion





5-Year Limited Warranty

RIKON Power Tools, Inc. (“Seller”) warrants to only the original retail consumer/purchaser of our products that each product be free from defects in materials and workmanship for a period of five (5) years from the date the product was purchased at retail. This warranty may not be transferred.

This warranty does not apply to defects due directly or indirectly to misuse, abuse, negligence, accidents, repairs, alterations, lack of maintenance or normal wear and tear. Under no circumstances will Seller be liable for incidental or consequential damages resulting from defective products. All other warranties, expressed or implied, whether of merchantability, fitness for purpose, or otherwise are expressly disclaimed by Seller. This warranty does not cover products used for commercial, industrial or educational purposes.

This limited warranty does not apply to accessory items such as blades, drill bits, sanding discs or belts and other related items.

Seller shall in no event be liable for death, injuries to persons or property, or for incidental, contingent, special, or consequential damages arising from the use of our products.

To take advantage of this warranty proof of purchase documentation, which includes date of purchase and an explanation of the complaint, must be provided.

The Seller reserves the right to effect at any time, without prior notice, those alterations to parts, fittings, and accessory equipment which they may deem necessary for any reason whatsoever.

To take advantage of this warranty, please fill out the enclosed warranty card and send it to:

RIKONWarranty
16 Progress Rd.
Billerica, MA. 01821

The card must be entirely completed in order for it to be valid. If you have any questions please contact us at 877-884-5167 or warranty@rikontools.com.

RIKON **POWER TOOLS**

For more information:
16 Progress Rd.
Billerica, MA. 01821

877-884-5167/978-528-5380
techsupport@rikontools.com
www.rikontools.com